

PLANTA LAVANDERIA - TERREO

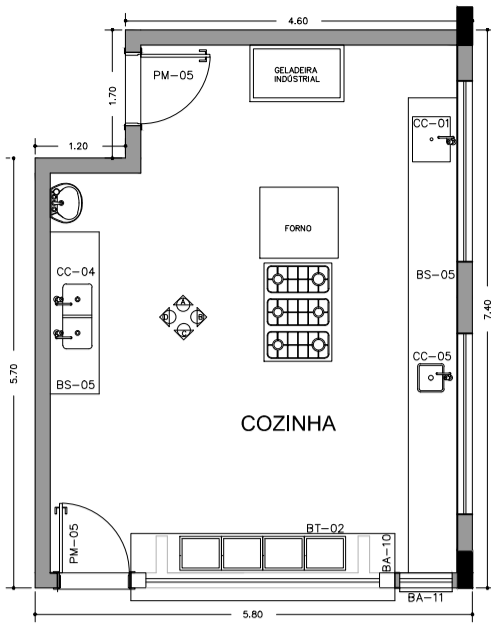

PLANTA COZINHA - TERREO

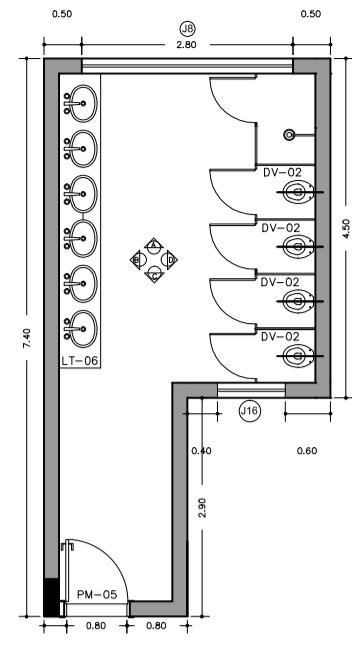

PLANTA W.C. FEMENINO - TERREO

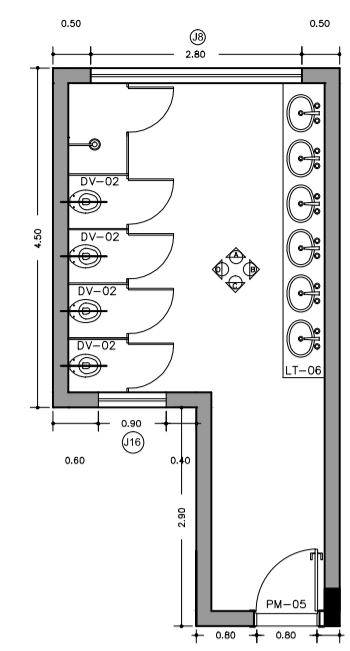

PLANTA W.C. MASCULINO - TERREO

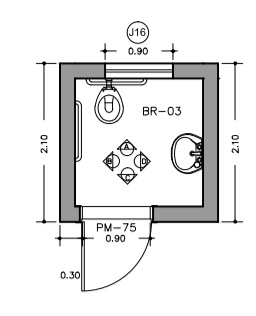

PLANTA W.C. DEFICIENTE FEMENINO - TERREO

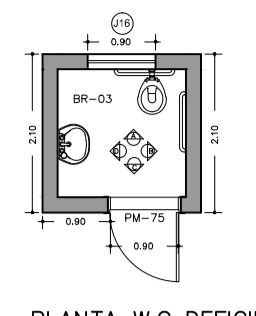

PLANTA W.C. DEFICIENTE MASCULINO - TERREO

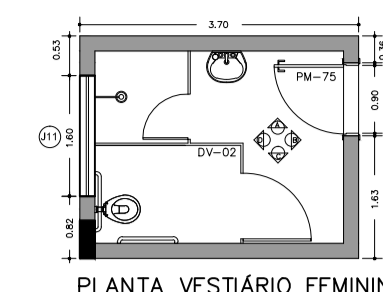

PLANTA VESTIÁRIO FEMININO - TERREO

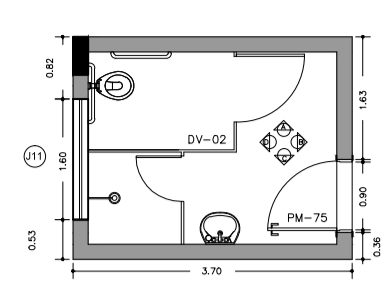

PLANTA VESTIÁRIO MASCULINO - TERREO

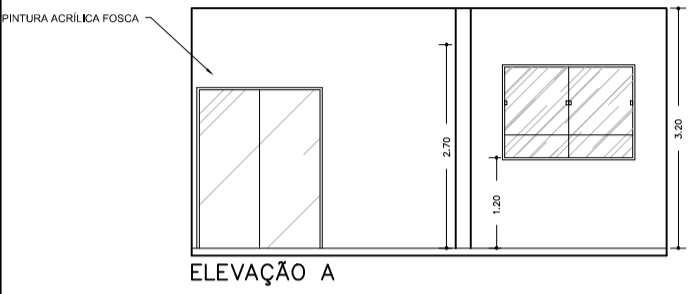

ELEVAÇÃO A

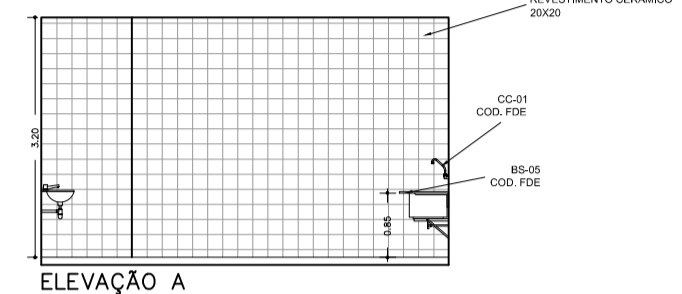

ELEVAÇÃO A

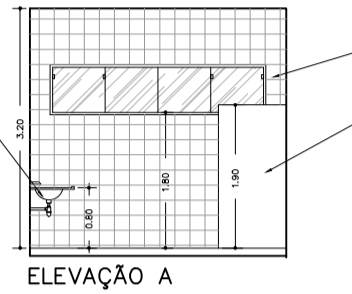

ELEVAÇÃO A

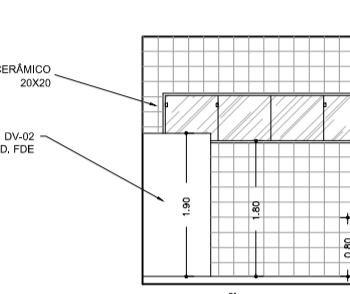

ELEVAÇÃO A

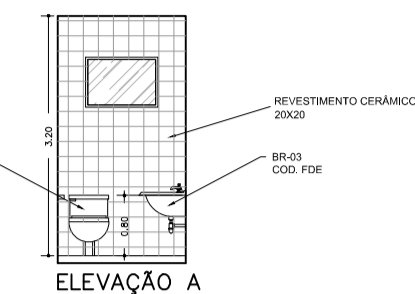

ELEVAÇÃO A

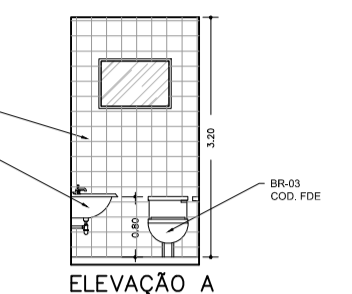

ELEVAÇÃO A



ELEVAÇÃO A



ELEVAÇÃO A

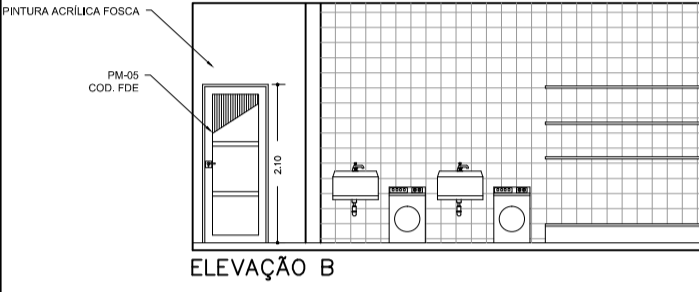

ELEVAÇÃO B

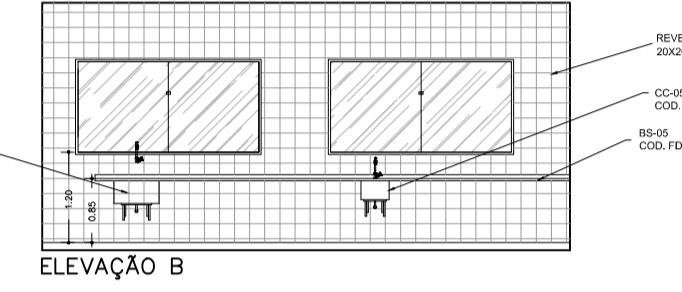

ELEVAÇÃO B

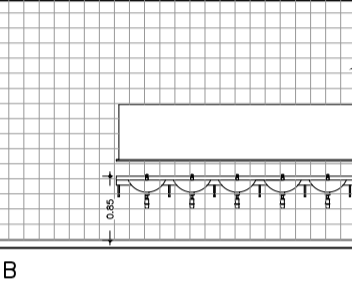

ELEVAÇÃO B

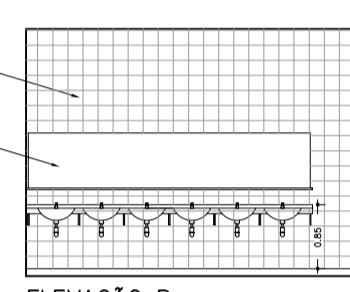

ELEVAÇÃO B

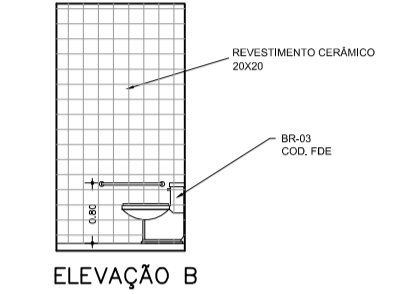

ELEVAÇÃO B

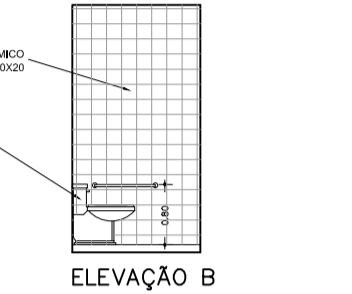

ELEVAÇÃO B

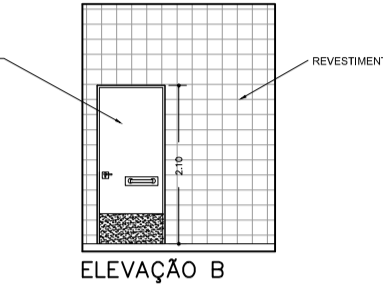

ELEVAÇÃO B

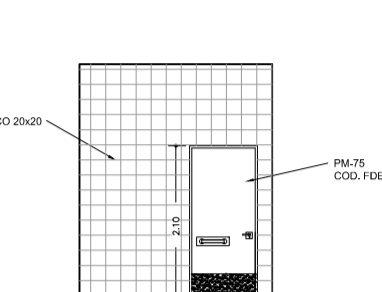

ELEVAÇÃO B

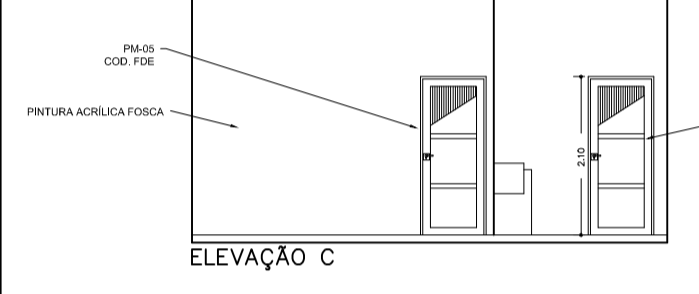

ELEVAÇÃO C

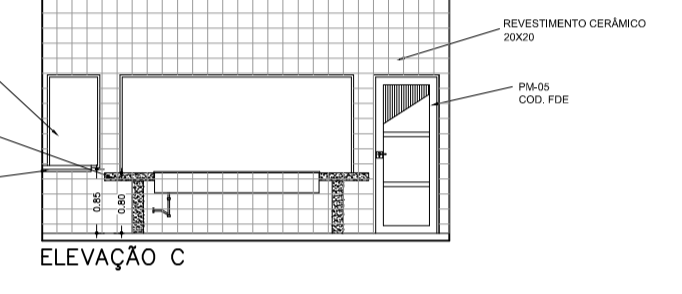

ELEVAÇÃO C

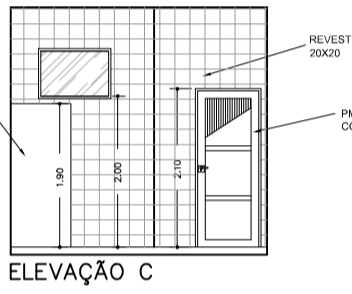

ELEVAÇÃO C

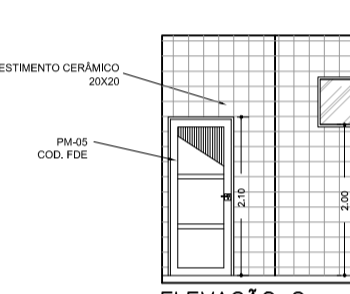

ELEVAÇÃO C

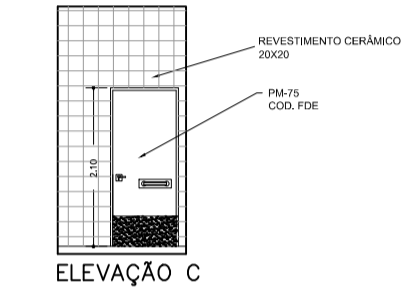

ELEVAÇÃO C

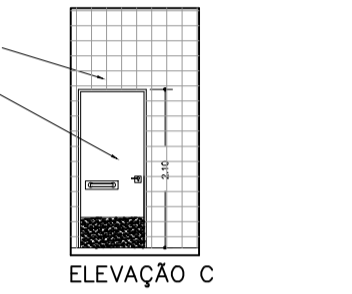

ELEVAÇÃO C



ELEVAÇÃO C

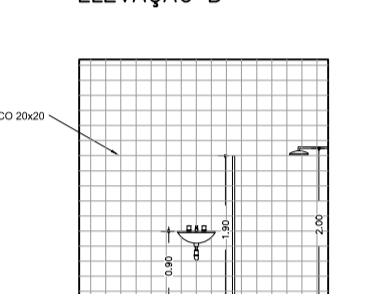

ELEVAÇÃO C

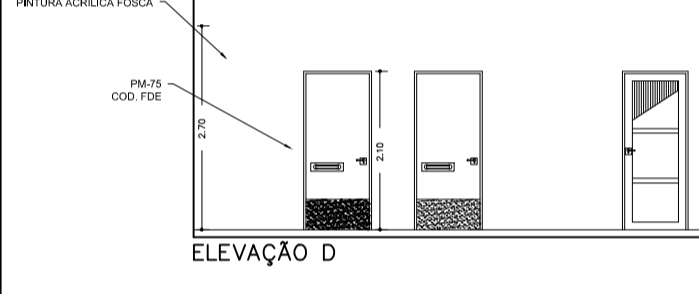

ELEVAÇÃO D

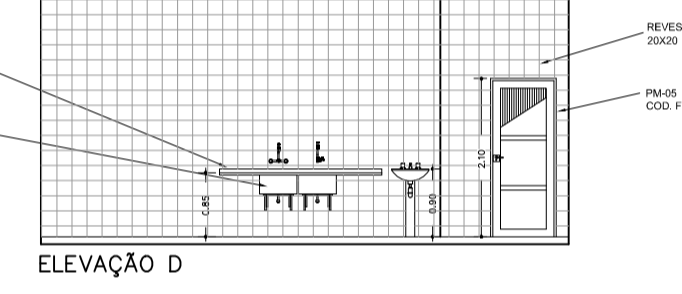

ELEVAÇÃO D

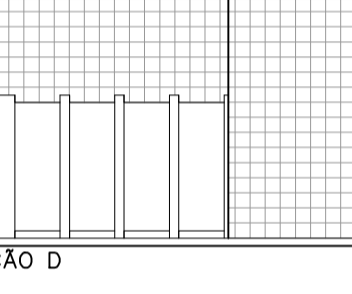

ELEVAÇÃO D

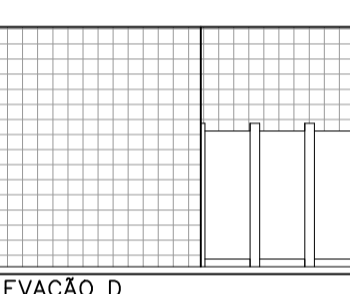

ELEVAÇÃO D

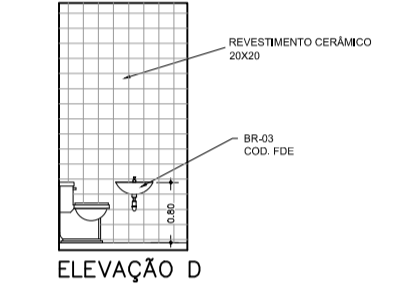

ELEVAÇÃO D

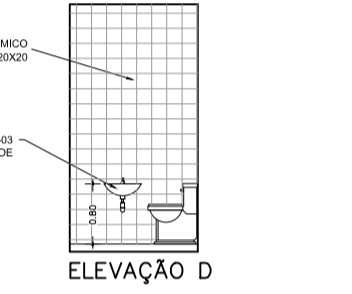

ELEVAÇÃO D

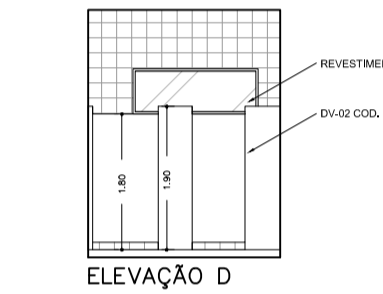

ELEVAÇÃO D

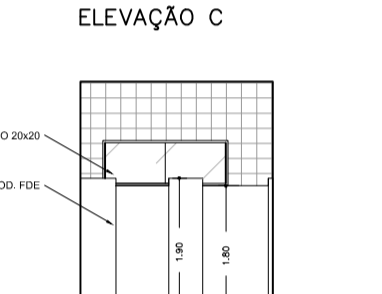

ELEVAÇÃO D

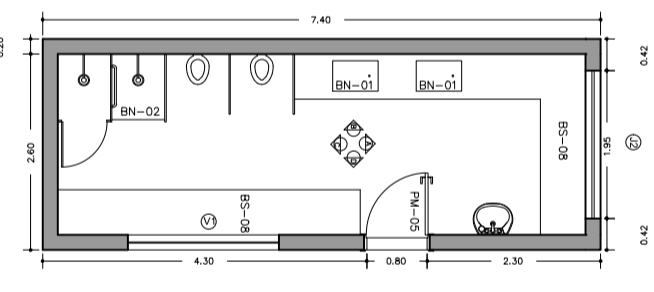

PLANTA BANHO/TROCA - TERREO

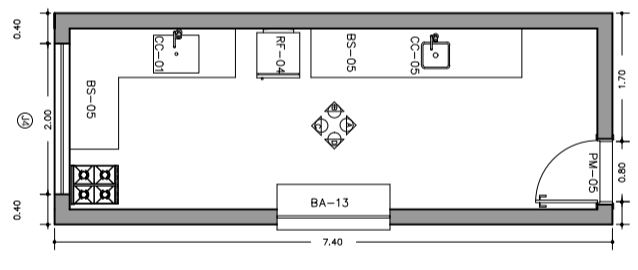

PLANTA LACTARIO - TERREO

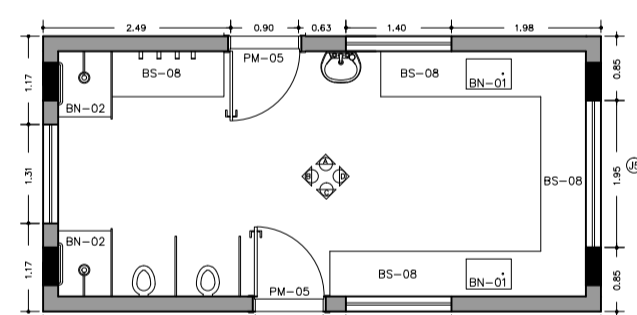

PLANTA BANHO/TROCA - TERREO

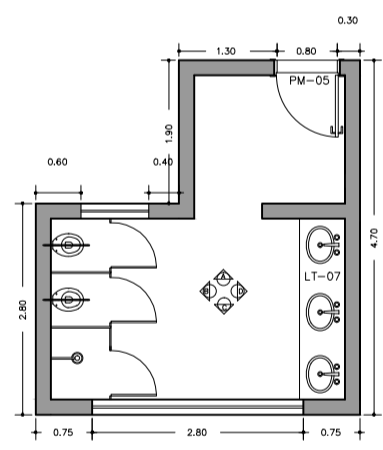

PLANTA W.C. FUNCIONÁRIOS - SUPERIOR

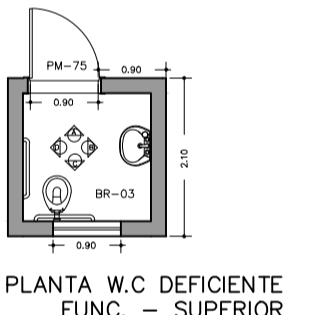

PLANTA W.C. DEFICIENTE FUNC. - SUPERIOR

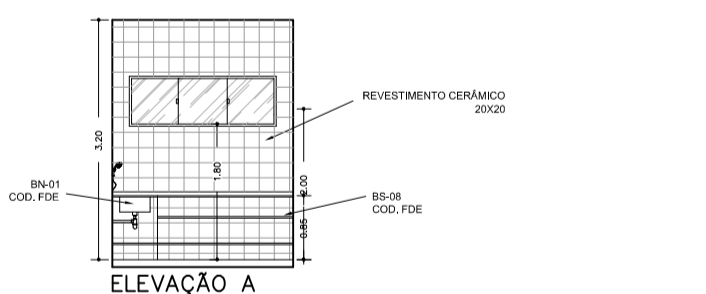

ELEVAÇÃO A

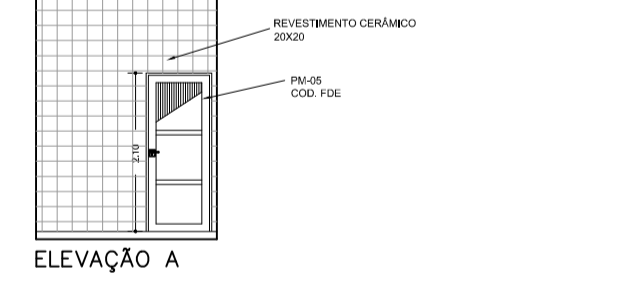

ELEVAÇÃO A

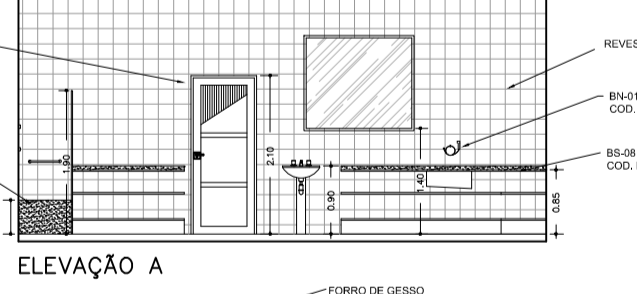

ELEVAÇÃO A



ELEVAÇÃO A

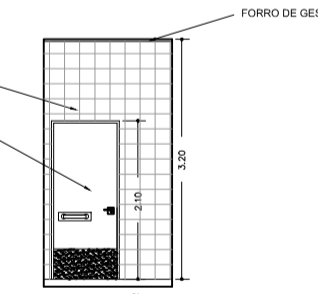

ELEVAÇÃO A

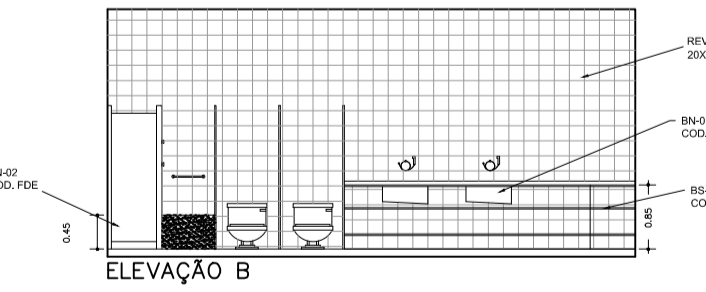

ELEVAÇÃO B

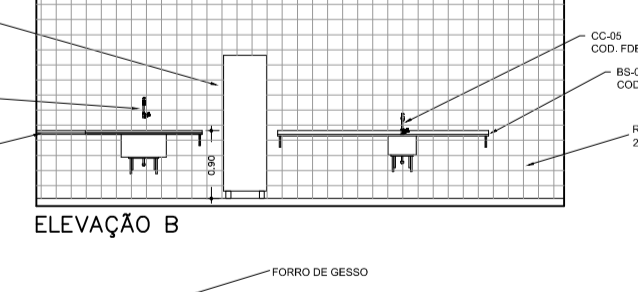

ELEVAÇÃO B

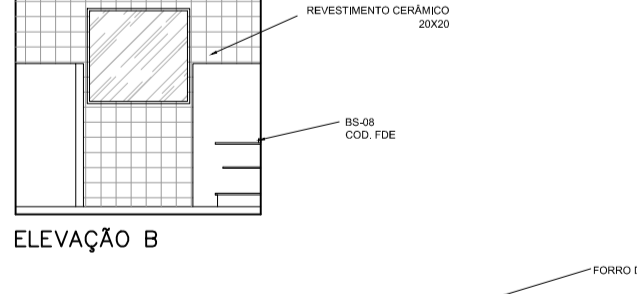

ELEVAÇÃO B



ELEVAÇÃO B

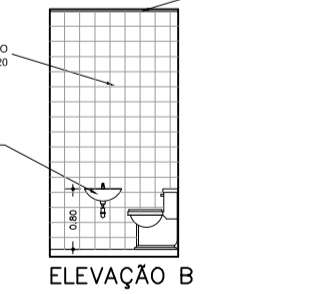

ELEVAÇÃO B

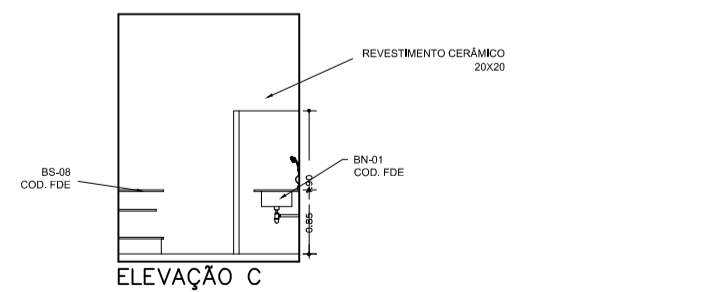

ELEVAÇÃO C

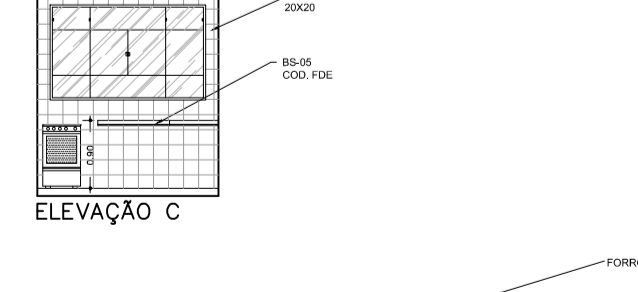

ELEVAÇÃO C



ELEVAÇÃO C



ELEVAÇÃO C

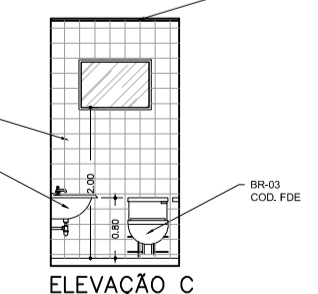

ELEVAÇÃO C

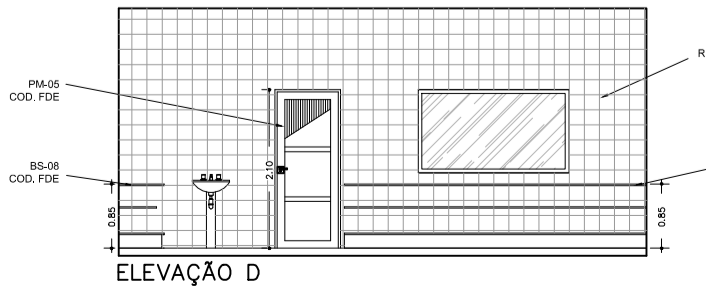

ELEVAÇÃO D

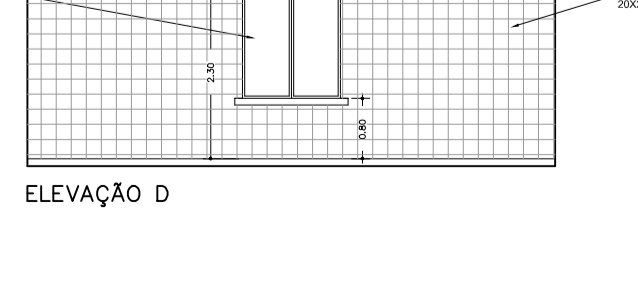

ELEVAÇÃO D

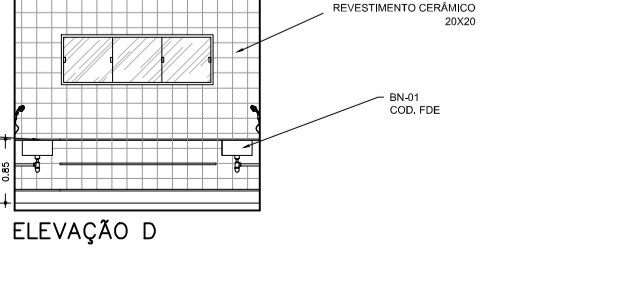

ELEVAÇÃO D



ELEVAÇÃO D

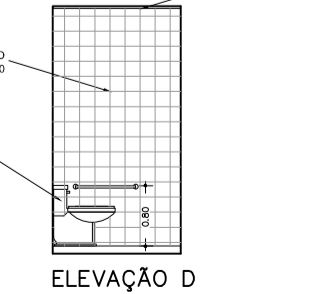

ELEVAÇÃO D

PROJETO ARQUITETÔNICO

Folha:  
09/11

EMEI VILA ARRUDA

ASSUNTO: DETALHAMENTO ÁREA MOLHADA  
LOCAL: RUA JOSÉ PÉRCIO DOS SANTOS  
ITAPETININGA-SP

ESCALAS INDICADAS

PLANTA DE SITUAÇÃO SEM ESCALA

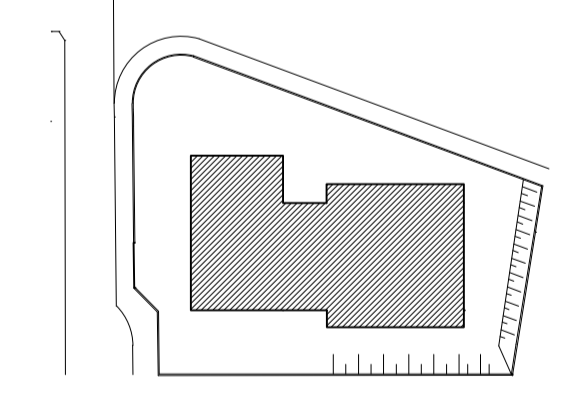

DECLARO QUE A APROVAÇÃO DO PROJETO, NÃO IMPLICA NO RECONHECIMENTO, POR PARTE DA PREFEITURA DO DIREITO DE PROPRIEDADE DO TERRENO.

PREFEITO MUNICIPAL

QUADRO DE ÁREAS

ÁREA DO TERRENO: 2666,74M<sup>2</sup>  
PAVIMENTO SUBSOLO: 590,84M<sup>2</sup>  
PAVIMENTO TERREO: 832,07M<sup>2</sup>  
PAVIMENTO SUPERIOR: 804,06M<sup>2</sup>  
TOTAL A CONSTRUIR: 2226,97M<sup>2</sup>

RESPONSÁVEL TÉCNICO  
ARQ. TIAGO RIBEIRO BARBOSA  
CAU: A74168-0